



ROURA

Distributed By:
Solution Dynamics Inc
877-860-3620

RUGGED HOPPER MODEL

4T-3/16-1080 4 CU YD



(SHOWN AS 3T-3/16-1080)

MODEL #	SIZE	L	W	H	LH	FORK OPENING	WEIGHT	CAPACITY
4T-3/16-1080	4 CU YD	71"	83 1/2"	61"	39 1/2"	2 1/2" X 37 1/2"	1412 LBS	8000 LBS

RUGGED 4T-3/16-1080

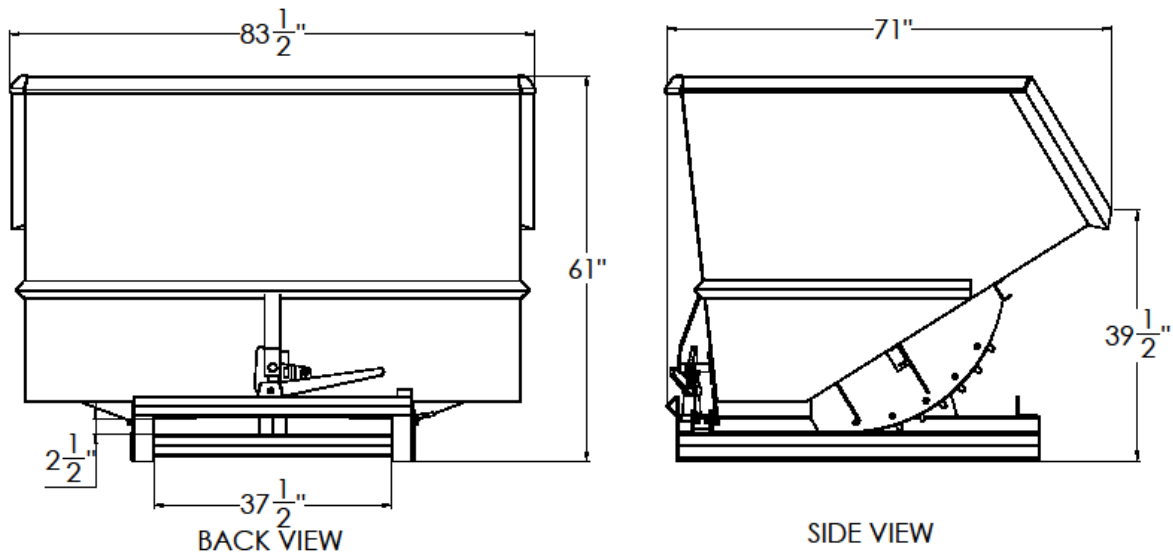

CONSTRUCTION: 7 gauge plate body and 5/16" formed box tube base. Bodies are 100% continuous weld for superior construction. Ductile iron handle, standard stops and secure flip latch are standard on this model.

FINISH: Bright safety green enamel paint (other colors optional).

OPTIONAL ITEMS ARE AVAILABLE
"FOR ALL YOUR MATERIAL HANDLING NEEDS!"